



Ersatzteilliste / Part List

AMF BRUNS „LINEARLIFT“

69 Ersatzteilliste / Part List





57 ERSATZTEILLISTE / PARTS LIST

69.1 Hinweise bei Ersatzteillieferungen

Lifttyp

Baujahr

Fabrik-Nr.

Artikel-Nr.

Bestellungen werden per **Telefax Nr. 0 44 89 - 6245** oder per eMail unter **manfred.meiners@amf-bruns.de** entgegengenommen.

69.2 Hinweise zur Garantielieferung

Garantieansprüche werden nur anerkannt, wenn diese vorher mit uns abgesprochen und genehmigt wurden.

69.3 Hinweise Austauschlieferung

Bei Austauschlieferungen (z.B. Garantie) bitten wir folgendes zu beachten:

1. Eine möglichst schnelle sowie kostengünstige Rücksendung der auszutauschenden Teile, da sonst Berechnung des Altteils zu Ihren Lasten erfolgt.
2. Bei Rücklieferung von auszutauschenden Teilen ist das Begleitschreiben unbedingt **getrennt** an uns zu senden:

AMF-Bruns GmbH & Co. KG
Abt. Hubmatik Kundendienst
Herr Manfred Meiners
 Hauptstraße 101
 26689 Apen



AMF-Bruns
 Gustav Bruns GmbH & Co. KG | Hauptstraße 101 | 26689 Apen
 Telefon +49 (0) 44 89 / 72 72 -22 | Fax +49 (0) 44 89 / 62 45
 hubmatik@amf-bruns.de

www.amf-bruns.de



Reg.-Nr.: Q1 0105027



58 ERSATZTEILLISTE / PARTS LIST

70 Directions for ordering spare parts

Please state:

Lift type

Year of manufacture

Serial no.

Item no.

Orders can be placed via telefax on 0049 4489 6245 or by email to manfred.meiners@amf-bruns.de.

70.1 Warranty

Warranty claims are only regulated if accepted and approved by AMF-Bruns beforehand.

70.2 Exchange delivery

In case of an exchange delivery (e.g. warranty claim):

1. Please return the parts that need exchanging as quickly and cost-savingly as possible, otherwise we will have to charge them to your account.
2. Please send the covering letter separately to the following address:

AMF-Bruns GmbH & Co. KG
Abt. Hubmatik Aftersales
FAO Mr. Manfred Meiners
 Hauptstraße 101
 26689 Apen / Germany



AMF-Bruns
 Gustav Bruns GmbH & Co. KG | Hauptstraße 101 | 26689 Apen
 Telefon +49 (0) 44 89 / 72 72 -22 | Fax +49 (0) 44 89 / 62 45
hubmatik@amf-bruns.de

www.amf-bruns.de



Reg.-Nr.: Q1 0105027



59 ERSATZTEILLISTE / PARTS LIST

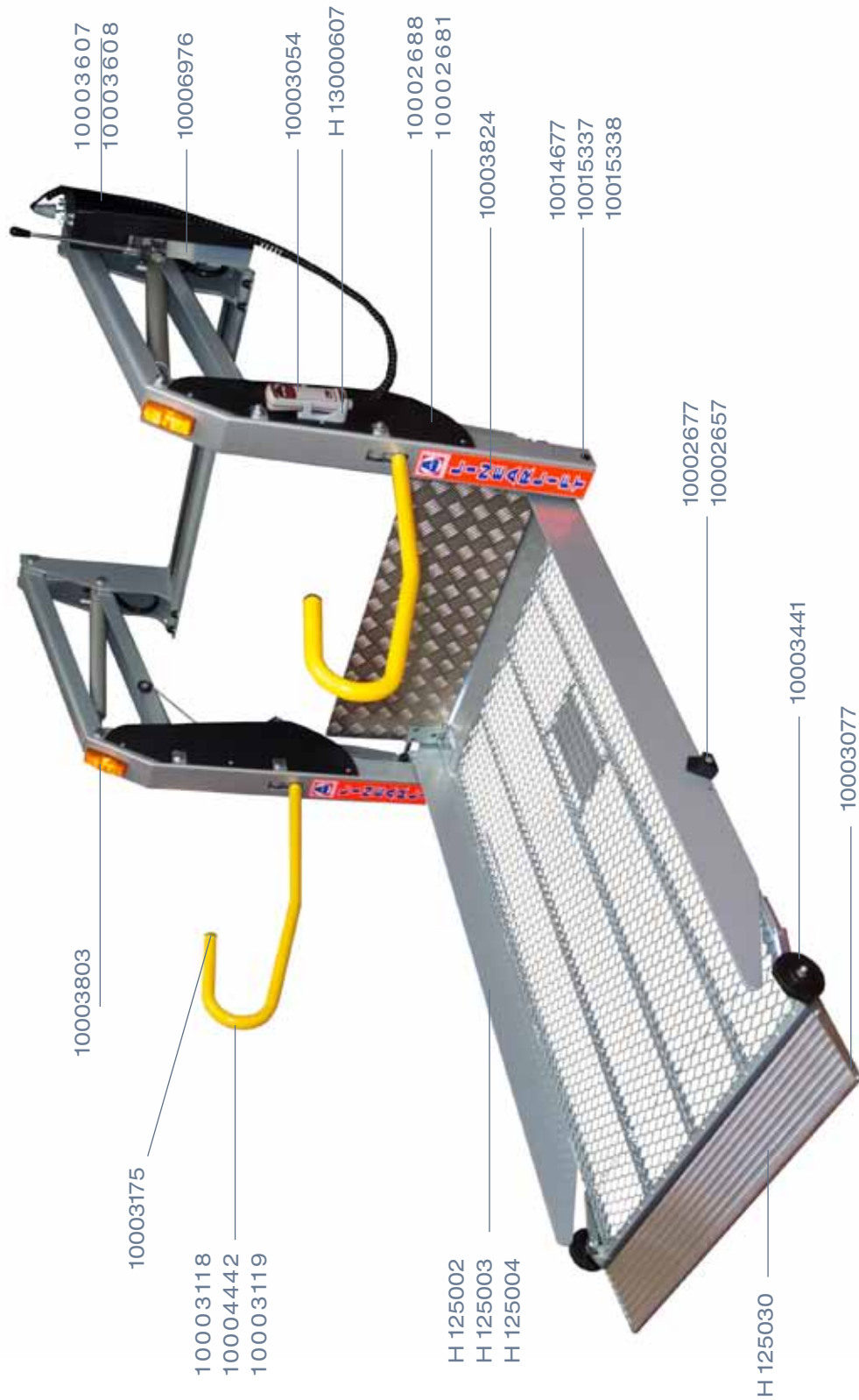

AMF-Bruns
 Gustav Bruns GmbH & Co. KG | Hauptstraße 101 | 26689 Apen
 Telefon +49 (0) 44 89 / 72 72 -22 | Fax +49 (0) 44 89 / 62 45
 hubmatik@amf-bruns.de

www.amf-bruns.de



Reg.-Nr.: Q1 0105027



60 ERSATZTEILLISTE / PARTS LIST

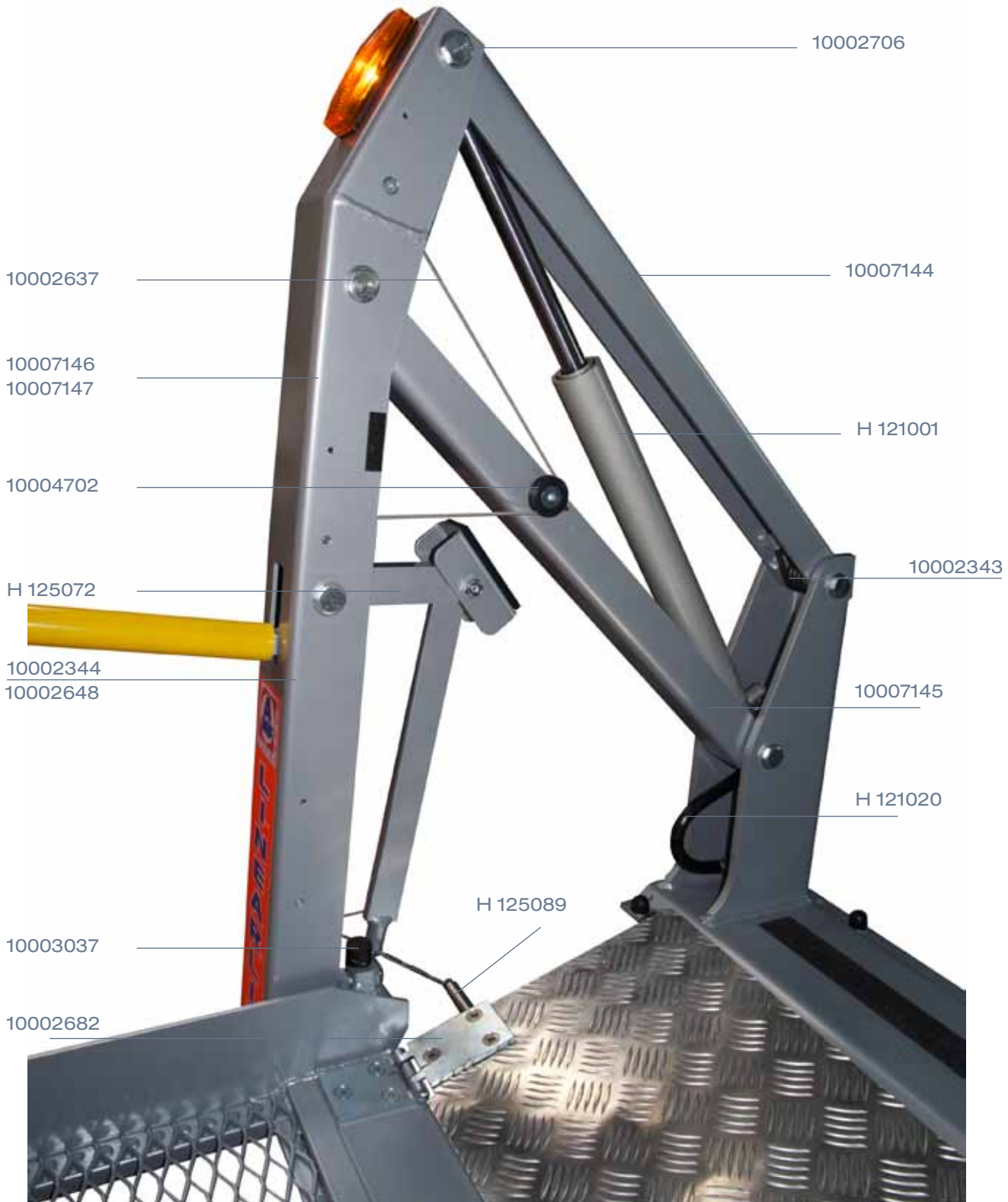

AMF-Bruns
Gustav Bruns GmbH & Co. KG | Hauptstraße 101 | 26689 Apen
Telefon +49 (0) 44 89 / 72 72 -22 | Fax +49 (0) 44 89 / 62 45
hubmatik@amf-bruns.de

www.amf-bruns.de



Reg.-Nr.: Q1 0105027



61 ERSATZTEILLISTE / PARTS LIST

Hubwerk / Spare Parts ab Bj. 11/2005 Fabrik-Nr. „GB...“

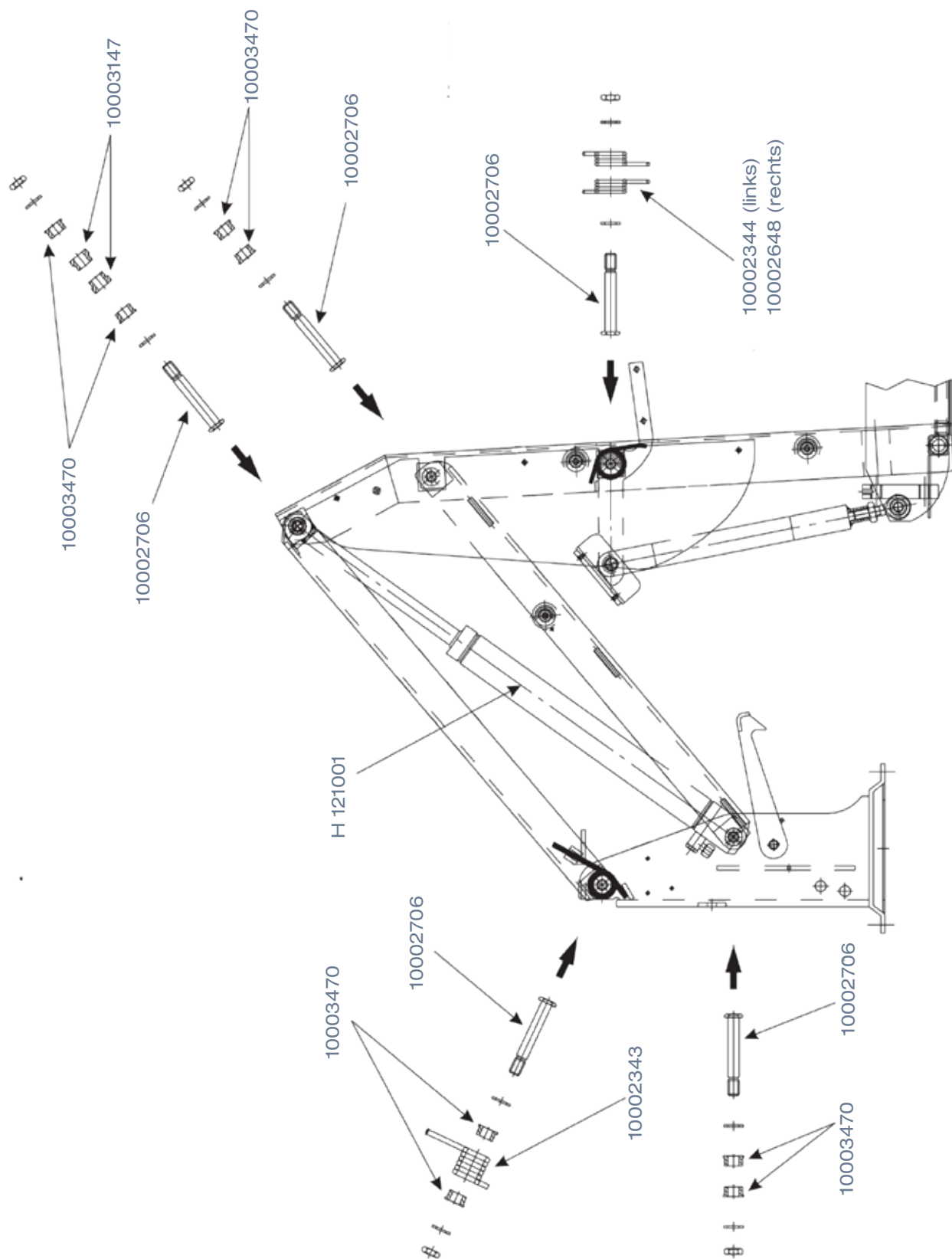

AMF-Bruns
 Gustav Bruns GmbH & Co. KG | Hauptstraße 101 | 26689 Apen
 Telefon +49 (0) 44 89 / 72 72 -22 | Fax +49 (0) 44 89 / 62 45
 hubmatik@amf-bruns.de

www.amf-bruns.de



Reg.-Nr.: Q1 0105027



62 ERSATZTEILLISTE / PARTS LIST

Ersatzteile für Lift „G“, Bj bis 11/2005 - Special parts for „G“-type only till 11/2005

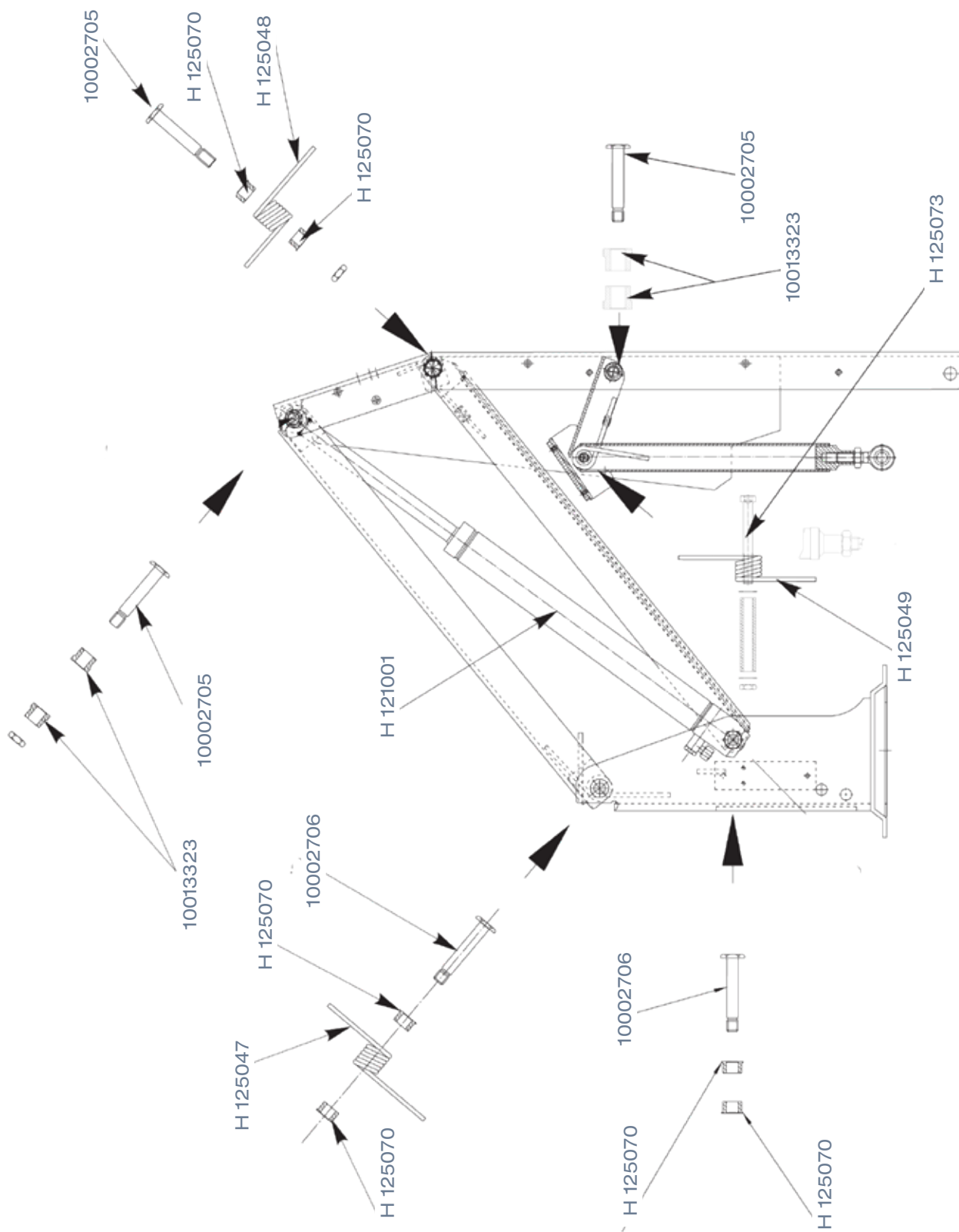

AMF-Bruns
Gustav Bruns GmbH & Co. KG | Hauptstraße 101 | 26689 Apen
Telefon +49 (0) 44 89 / 72 72 -22 | Fax +49 (0) 44 89 / 62 45
hubmatik@amf-bruns.de

www.amf-bruns.de



Reg.-Nr.: Q1 0105027



63 ERSATZTEILLISTE / PARTS LIST

Art.-No. / Code	Bild / picture	Beschreibung/description
10006976		<p>Hydraulikaggregat Handpumpe 0,5kW, 12VDC, 0,5ccm/U, 1,8 Liter Kunststofftank</p> <p><i>Hydraulic power pack with hand pump, 0,5kW, 12VDC, 0,5ccm/U, 1,8 litre</i></p>
H123003		<p>AMF-Motor 12 Volt 0,5 kW LL</p> <p><i>Electric motor 12V DC, 0,5kW</i></p>
10003607		<p>Aggregatabdeckung rechts</p> <p><i>Power pack cover, right</i></p>
10003608		<p>Aggregatabdeckung links</p> <p><i>Power pack cover, left</i></p>



AMF-Bruns
 Gustav Bruns GmbH & Co. KG | Hauptstraße 101 | 26689 Apen
 Telefon +49 (0) 44 89 / 72 72 -22 | Fax +49 (0) 44 89 / 62 45
 hubmatik@amf-bruns.de

www.amf-bruns.de



Reg.-Nr.: Q1 0105027



64 ERSATZTEILLISTE / PARTS LIST

Art.-No. / Code	Bild / picture	Beschreibung/description
10015229		<p>Handpumpe bestehend aus Hebel und Gußgehäuse</p> <p><i>Hand pump device (lever and metal housing)</i></p>
H123016		<p>Verlängerung Notsenken</p> <p><i>Extension emergency release</i></p>
10008080		<p>Sicherungshalter 4-polig</p> <p><i>Fuse holder 4-pole</i></p>
10003498		<p>Masseleitung 1,5mm², braun</p> <p><i>Earth wire 1,5mm², brown</i></p>



AMF-Brunns
Gustav Bruns GmbH & Co. KG | Hauptstraße 101 | 26689 Apen
Telefon +49 (0) 44 89 / 72 72 -22 | Fax +49 (0) 44 89 / 62 45
hubmatik@amf-bruns.de

www.amf-bruns.de



Reg.-Nr.: Q1 0105027



65 ERSATZTEILLISTE / PARTS LIST

Art.-No. / Code	Bild / picture	Beschreibung/description
10002689		<p>Sitzventil 12V mit Nothand</p> <p><i>Lowering valve 12V with emergency release</i></p>
10002694		<p>Spule 12V DC für Gr. 08</p> <p><i>Solenoid, 12V DC</i></p>
H123007		<p>Senkventil mit Nothand und Magnetspule 12V, stromlos geschlossen</p> <p><i>Lowering valve with solenoid 12V</i></p>
10002696		<p>Starterschalter 12V DC (Schalterschütz)</p> <p><i>Contactor, 12V DC</i></p>



AMF-Bruns
 Gustav Bruns GmbH & Co. KG | Hauptstraße 101 | 26689 Apen
 Telefon +49 (0) 44 89 / 72 72 -22 | Fax +49 (0) 44 89 / 62 45
 hubmatik@amf-bruns.de

www.amf-bruns.de



Reg.-Nr.: Q1 0105027



66 ERSATZTEILLISTE / PARTS LIST

Art.-No. / Code	Bild / picture	Beschreibung/description
H123012		Einfüllstutzen mit Verschlusskappe <i>Filler neck with cap</i>
H121001		Hydraulikzylinder, komplett mit Buchsen <i>Hydraulic cylinder for linear lift</i>
H121020		Hydraulikschlauch PHD 106 x 390 AFL <i>Hydraulic hose PHD 106 x 390 AFL</i>
10015313		3-Fach-Verteiler links, OLD-VOD-1-2 <i>3-way distributor left, OLD-VOD-1-2</i>



AMF-Bruns
Gustav Bruns GmbH & Co. KG | Hauptstraße 101 | 26689 Apen
Telefon +49 (0) 44 89 / 72 72 -22 | Fax +49 (0) 44 89 / 62 45
hubmatik@amf-bruns.de

www.amf-bruns.de



Reg.-Nr.: Q1 0105027



67 ERSATZTEILLISTE / PARTS LIST

Art.-No. / Code	Bild / picture	Beschreibung/description
10009650		Schwenkverschraubung 90°, XSWR NW 06 HL <i>Swivel joint 90°, XSWR NW 06 HL</i>
10015513		W-Verschraubung, XVEW 0 NW 06 HL <i>Angled screw coupling, XVEW 0 NW 06 HL</i>
10003118		Geländer Standard (lang), gelb <i>Handrail hooked, yellow</i>
10003119		Geländer kurz, gelb <i>Handrail short, yellow</i>



AMF-Bruns
 Gustav Bruns GmbH & Co. KG | Hauptstraße 101 | 26689 Apen
 Telefon +49 (0) 44 89 / 72 72 -22 | Fax +49 (0) 44 89 / 62 45
 hubmatik@amf-bruns.de

www.amf-bruns.de



Reg.-Nr.: Q1 0105027



68 ERSATZTEILLISTE / PARTS LIST

Art.-No. / Code	Bild / picture	Beschreibung/description
10003120		<p>Geländer englische Ausführung, rechts, gelb</p> <p><i>Handrail English version, right, yellow</i></p>
10003121		<p>Geländer englische Ausführung, links, gelb</p> <p><i>Handrail English version, left, yellow</i></p>
10004442		<p>Geländer Flexitrans</p> <p><i>Handrail type Flexitrans, yellow</i></p>
10003175		<p>Gleiter GL, AD=34, schwarz, Abdeckkappe für Geländer</p> <p><i>Cap GL, AD=34, black</i></p>



AMF-Brunns
Gustav Bruns GmbH & Co. KG | Hauptstraße 101 | 26689 Apen
Telefon +49 (0) 44 89 / 72 72 -22 | Fax +49 (0) 44 89 / 62 45
hubmatik@amf-bruns.de

www.amf-bruns.de



Reg.-Nr.: Q1 0105027



69 ERSATZTEILLISTE / PARTS LIST

Art.-No. / Code	Bild / picture	Beschreibung/description
10007146		Tragholm links <i>Supporting arm left</i>
10007147		Tragholm rechts <i>Supporting arm right</i>
10007144		Tragarmprofil oben links/rechts <i>Supporting arm top left/right</i>
10007145		Tragarmprofil unten links/rechts <i>Supporting arm bottom left/right</i>



AMF-Bruns
 Gustav Bruns GmbH & Co. KG | Hauptstraße 101 | 26689 Apen
 Telefon +49 (0) 44 89 / 72 72 -22 | Fax +49 (0) 44 89 / 62 45
 hubmatik@amf-bruns.de

www.amf-bruns.de



Reg.-Nr.: Q1 0105027



70 ERSATZTEILLISTE / PARTS LIST

Art.-No. / Code	Bild / picture	Beschreibung/description
10003803		<p>Seitenmarkierungsleuchte m. Rückstrahler, o. Glühlampe für Linearlift</p> <p><i>Flashing light for linear lift</i></p>
10003824		<p>„Linearlift“ Aufkleber, 3-farbig, 40 x 7cm</p> <p><i>„Linearlift“ sticker, 40 x 7 cm</i></p>
H125072		<p>Kniegelenk mit Kugelaug</p> <p><i>Toggle joint complete with side spring and eye ball</i></p>
10002382		<p>Gelenkkopf SA 15 ES für Kniegelenk</p> <p><i>Eye ball SA 15 ES for toggle joint</i></p>



AMF-Bruns
Gustav Bruns GmbH & Co. KG | Hauptstraße 101 | 26689 Apen
Telefon +49 (0) 44 89 / 72 72 -22 | Fax +49 (0) 44 89 / 62 45
hubmatik@amf-bruns.de

www.amf-bruns.de



Reg.-Nr.: Q1 0105027



71 ERSATZTEILLISTE / PARTS LIST

Art.-No. / Code	Bild / picture	Beschreibung/description
10007137		Anschlagprofil Kniegelenk <i>Toggle joint profile</i>
10003006		Scheuerschutz, schwarz für Kniegelenk <i>Cover for toggle joint profile, plastic, black</i>
H125073		Inbusschraube mit Kunststoffbuchse <i>Socket head cap screw with bush for toggle joint</i>
10003037		Gummipuffer D025xL020, M8x12 <i>Rubber stop D025xL020, M8x12</i>



AMF-Bruns
Gustav Bruns GmbH & Co. KG | Hauptstraße 101 | 26689 Apen
Telefon +49 (0) 44 89 / 72 72 -22 | Fax +49 (0) 44 89 / 62 45
hubmatik@amf-bruns.de

www.amf-bruns.de



Reg.-Nr.: Q1 0105027



72 ERSATZTEILLISTE / PARTS LIST

Art.-No. / Code	Bild / picture	Beschreibung/description
10002681		Seitenverkleidung links für „GB“-Modell <i>Plastic side cover, left, for type „GB“</i>
10002688		Seitenverkleidung rechts für „GB“-Modell <i>Plastic side cover, right, for type „GB“</i>
10002343		Schenkelfeder Tragholm oben, für „GB“-Modell <i>Side spring at the top bracket, type „GB“</i>
10002344		Schenkelfeder, Kniegelenk links für „GB“-Modell <i>Side spring for toggle joint, left, type „GB“</i>



AMF-Brunns
Gustav Bruns GmbH & Co. KG | Hauptstraße 101 | 26689 Apen
Telefon +49 (0) 44 89 / 72 72 -22 | Fax +49 (0) 44 89 / 62 45
hubmatik@amf-bruns.de

www.amf-bruns.de



Reg.-Nr.: Q1 0105027



73 ERSATZTEILLISTE / PARTS LIST

Art.-No. / Code	Bild / picture	Beschreibung/description
10002648		<p>Schenkelfeder, Kniegelenk rechts für „GB“-Modell</p> <p><i>Side spring for toggle joint, right, type „GB“</i></p>
10000000		<p>Scheuerleiste links, 290 x 30 x 4</p> <p><i>Glide strip left, 290 x 30 x 4, black plastic</i></p>
10003686		<p>Scheuerleiste rechts, 290 x 30 x 4</p> <p><i>Glide strip right, 290 x 30 x 4, black plastic</i></p>
10002661		<p>Grenztaster/Winkelrollenhebel, Kabel 2 x 1,0 qmm / L = 800 mm</p> <p><i>Limit switch LS-11S with wire 2 x 1,0 qmm / L = 800 mm</i></p>



AMF-Bruns
 Gustav Bruns GmbH & Co. KG | Hauptstraße 101 | 26689 Apen
 Telefon +49 (0) 44 89 / 72 72 -22 | Fax +49 (0) 44 89 / 62 45
 hubmatik@amf-bruns.de

www.amf-bruns.de



Reg.-Nr.: Q1 0105027



74 ERSATZTEILLISTE / PARTS LIST

Art.-No. / Code	Bild / picture	Beschreibung/description
10003693		Grenztaster/Winkelrollenhebel, Kabel 2 x 1,0 qmm / L = 1700 mm <i>Limit switch LS-11S with wire 2 x 1,0 qmm / L = 1700 mm</i>
10003805		Blinkgeber 12V <i>Flasher unit 12V</i>
10002706		Paßschraube M16 x 113, Modell „GB“ <i>Bolt M16, L1 = 113 mm for type „GB“</i>
10003146		Buchse Plattform unten klein, \varnothing 30 / \varnothing 18,3...7,5 <i>Bush for platform, small, \varnothing 30 / \varnothing 18,3...7,5</i>



AMF-Brunns
Gustav Bruns GmbH & Co. KG | Hauptstraße 101 | 26689 Apen
Telefon +49 (0) 44 89 / 72 72 -22 | Fax +49 (0) 44 89 / 62 45
hubmatik@amf-bruns.de

www.amf-bruns.de



Reg.-Nr.: Q1 0105027



75 ERSATZTEILLISTE / PARTS LIST

Art.-No. / Code	Bild / picture	Beschreibung/description
10003167		<p>Buchse Kniehebel, $\varnothing 26 / \varnothing 20,4...12$ <i>Bush toggle lever, $\varnothing 26 / \varnothing 20,4...12$</i></p>
10003642		<p>Buchse Plattform unten groß, $\varnothing 30 / \varnothing 18,3...55$ <i>Bush for platform, $\varnothing 30 / \varnothing 18,3...55$</i></p>
10003148		<p>Buchse Kniehebel, $\varnothing 32,3 / \varnothing 16,3...30$ <i>Bush for toggle joint, $\varnothing 32,3 / \varnothing 16,3...30$</i></p>
10003373		<p>Buchse Zylinder oben, $\varnothing 30 / \varnothing 16,5...18,5$ <i>Bush for cylinder top, $\varnothing 30 / \varnothing 16,5...18,5$</i></p>



AMF-Bruns
Gustav Bruns GmbH & Co. KG | Hauptstraße 101 | 26689 Apen
Telefon +49 (0) 44 89 / 72 72 -22 | Fax +49 (0) 44 89 / 62 45
hubmatik@amf-bruns.de





www.amf-bruns.de



Reg.-Nr.: Q1 0105027

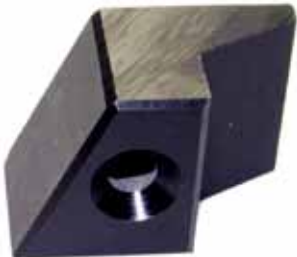

76 ERSATZTEILLISTE / PARTS LIST

Art.-No. / Code	Bild / picture	Beschreibung/description
10003147		<p>Buchse Tragarmhalterung für Hubwerk Linearlift, $\varnothing 25/\varnothing 16 \dots 39$</p> <p><i>Bush for supporting arm, $\varnothing 25/\varnothing 16 \dots 39$</i></p>
10003470		<p>Buchse Tragarm, 30/16,4 ... 17</p> <p><i>Bush for supporting arm, 30/16,4 ... 17</i></p>
10002677		<p>Anschlag, Typ Easy Access (EA), rechts</p> <p><i>Plastic rubber stop, type Easy Access (EA), right</i></p>
10002657		<p>Anschlag, Typ Easy Access (EA), links</p> <p><i>Plastic rubber stop, type Easy Access (EA), left</i></p>



AMF-Bruns
Gustav Bruns GmbH & Co. KG | Hauptstraße 101 | 26689 Apen
Telefon +49 (0) 44 89 / 72 72 -22 | Fax +49 (0) 44 89 / 62 45
hubmatik@amf-bruns.de

www.amf-bruns.de



Reg.-Nr.: Q1 0105027



77 ERSATZTEILLISTE / PARTS LIST

Art.-No. / Code	Bild / picture	Beschreibung/description
10004732		<p>Anschlag kurz rechts, EATP, EASP <i>Plastic rubber stop, right, type EATP, EASP</i></p>
10004733		<p>Anschlag kurz links, EATP, EASP <i>Plastic rubber stop, left, type EATP, EASP</i></p>
10003054		<p>Handschalter, 2-Taster, grau <i>Hand control with spiral cable, 2 buttons</i></p>
H13000607		<p>Halter für Handdrucktaster „Quick“ <i>Holder for hand control</i></p>



AMF-Bruns
Gustav Bruns GmbH & Co. KG | Hauptstraße 101 | 26689 Apen
Telefon +49 (0) 44 89 / 72 72 -22 | Fax +49 (0) 44 89 / 62 45
hubmatik@amf-bruns.de

www.amf-bruns.de



Reg.-Nr.: Q1 0105027



78 ERSATZTEILLISTE / PARTS LIST

Art.-No. / Code	Bild / picture	Beschreibung/description
H125002		Hubplattform Easy Access Typ EA 1500 <i>Platform Easy Access EA 1500</i>
H125003		Hubplattform Easy Access Typ EA 1185 <i>Platform Easy Access EA 1185</i>
H125004		Hubplattform Easy Access Typ EA 1250 <i>Platform Easy Access EA 1250</i>
H125180		Splittplattform, kompl. für EASP 1085 S <i>Split platform, complete for EASP 1085 S</i>
H125182		Splittplattform, kompl. für EASP 1085 <i>Split platform, complete for EASP 1085</i>
H125184		Splittplattform, kompl. für EASP 1300 <i>Split platform, complete for EASP 1300</i>
H125186		Splittplattform, kompl. für EASP 1600 <i>Split platform, complete for EASP 1600</i>



AMF-Bruns
 Gustav Bruns GmbH & Co. KG | Hauptstraße 101 | 26689 Apen
 Telefon +49 (0) 44 89 / 72 72 -22 | Fax +49 (0) 44 89 / 62 45
 hubmatik@amf-bruns.de

www.amf-bruns.de



Reg.-Nr.: Q1 0105027



79 ERSATZTEILLISTE / PARTS LIST

Art.-No. / Code	Bild / picture	Beschreibung/description
H125190		Teleskopplattform EATP 1002 kompl. mit Abrollsicherung <i>Telescopic platform EATP 1002 with roll-off stop</i>
H125192		Teleskopplattform EATP 1082 kompl. mit Abrollsicherung <i>Telescopic platform EATP 1082 with roll-off stop</i>
10014677		Scharnierbolzen für Hubplattform EA 1500 <i>Hinge bolt for platform - Linearlift</i>
10015337		EA 1250
10015338		EA 1185
10004628		Gleiter GL, AD = 20, schwarz <i>Cap GL, AD = 20, black</i>
H125250		Nachrüstset - Haken, Plattformsicherung <i>Device for platform locking</i>
10003116		Schutzstreifen für Hubplattform, 200 x 30 mm <i>Aluminium protection strip, 200 x 30 mm</i>



AMF-Bruns
Gustav Bruns GmbH & Co. KG | Hauptstraße 101 | 26689 Apen
Telefon +49 (0) 44 89 / 72 72 -22 | Fax +49 (0) 44 89 / 62 45
hubmatik@amf-bruns.de

www.amf-bruns.de



Reg.-Nr.: Q1 0105027

80 ERSATZTEILLISTE / PARTS LIST

Art.-No. / Code	Bild / picture	Beschreibung/description
10004631		<p>Typenschild „Achtung“, deutsch <i>Type plate „Achtung“, German</i></p>
10003440		<p>Typenschild „Attention“, englisch <i>Type plate „Attention“, English</i></p>
10008945		<p>Typenschild „Attention“, französisch <i>Type plate „Attention“, French</i></p>
10003429		<p>Typenschild „Opgelet“, holländisch <i>Type plate „Achtung“, Dutch</i></p>
H13000165		
H13000175		<p>Überrollklappe Typ EA 1185; 730 x 320 mm an Plattform <i>Bridge plate for EA 1185; 730 x 320 mm at platform</i></p>
H13000185		<p>Überrollklappe Typ EA 1500 900 x 320 mm an Plattform <i>Bridge plate for EA 1500 900 x 320 mm at platform</i></p>
H13000195		<p>Überrollklappe Typ EATP 1082 780 x 320 mm an Plattform <i>Bridge plate EATP 1082 780 x 320 mm at platform</i></p>



81 ERSATZTEILLISTE / PARTS LIST

Art.-No. / Code	Bild / picture	Beschreibung/description
H13000205		<p>Überrollklappe Typ EATP 1002 700 x 320 mm an Plattform</p> <p><i>Bridge plate EATP 1002 700 x 320 mm at platform</i></p>
H13000215		<p>Überrollklappe Typ EASP 1085 730 x 320mm an Plattform</p> <p><i>Bridge plate EASP 1085 730 x 320mm at platform</i></p>
H13000220		<p>Überrollklappe Typ EASP 1085S 650 x 320mm an Plattform</p> <p><i>Bridge plate for EASP 1085S 650 x 320mm at platform</i></p>
H13000225		<p>Überrollklappe Typ EASP 1300 / 1600 810 x 320 mm an Plattform</p> <p><i>Bridge plate EASP 1300 / 1600 810 x 320 mm at platform</i></p>
H13000170		<p>Überrollklappe Typ EA 1185; 730 x 350 mm am Bock</p> <p><i>Bridge plate for EA 1185; 730 x 350 mm at lift side</i></p>
H13000180		<p>Überrollklappe Typ EA 1250; 810 x 350 mm am Bock</p> <p><i>Bridge plate for 1250; 810 x 350 mm at lift side</i></p>
H13000190		<p>Überrollklappe Typ EA 1500 900 x 350 mm am Bock</p> <p><i>Bridge plate EA 1500 900 x 350 mm at lift side</i></p>
H13000200		<p>Überrollklappe Typ EATP 1082; 780 x 350 mm am Bock</p> <p><i>Bridge plate EATP 1082; 780 x 350 mm at lift side</i></p>



AMF-Bruns
 Gustav Bruns GmbH & Co. KG | Hauptstraße 101 | 26689 Apen
 Telefon +49 (0) 44 89 / 72 72 -22 | Fax +49 (0) 44 89 / 62 45
 hubmatik@amf-bruns.de

www.amf-bruns.de



Reg.-Nr.: Q1 0105027



82 ERSATZTEILLISTE / PARTS LIST

Art.-No. / Code	Bild / picture	Beschreibung/description
H13000210		<p>Überrollklappe Typ EATP 1002 700 x 350 mm am Bock</p> <p><i>Bridge plate EATP 1002 700 x 350 mm at lift side</i></p>
10003031		<p>Gummipuffer D015 für Überrollblech</p> <p><i>Rubber stop D015 x L006, M6 x 10 for bridge flap</i></p>
10002637		<p>Seil zur Überrollklappe, Länge 1136 mm</p> <p><i>Steel rope for automatic bridge flap (1136 mm)</i></p>
10003461		<p>Einschraubauge für Seil, M5 x 25 mm</p> <p><i>Eyelet M5 x 25 mm for flap cable</i></p>



AMF-Bruns
Gustav Bruns GmbH & Co. KG | Hauptstraße 101 | 26689 Apen
Telefon +49 (0) 44 89 / 72 72 -22 | Fax +49 (0) 44 89 / 62 45
hubmatik@amf-bruns.de

www.amf-bruns.de



Reg.-Nr.: Q1 0105027



83 ERSATZTEILLISTE / PARTS LIST

Art.-No. / Code	Bild / picture	Beschreibung/description
H125090		<p>Seilrolle mit Senkschraube zum Überrollblech</p> <p><i>Rope pulley with countersunk bolt for bridge flap.</i></p>
10004702		<p>Rolle zum Seilzug mit Schräge</p> <p><i>Rope pulley with inclined surface</i></p>
H125092		<p>Seilrolle mit Sechskantschraube und Unterlegscheibe zum Überrollblech</p> <p><i>Rope pulley with hexagon head screw and washer for bridge flap</i></p>
10004701		<p>Rolle zum Seilzug mit Ansatz</p> <p><i>Rope pulley with shoulder</i></p>



AMF-Bruns
 Gustav Bruns GmbH & Co. KG | Hauptstraße 101 | 26689 Apen
 Telefon +49 (0) 44 89 / 72 72 -22 | Fax +49 (0) 44 89 / 62 45
 hubmatik@amf-bruns.de

www.amf-bruns.de



Reg.-Nr.: Q1 0105027



84 ERSATZTEILLISTE / PARTS LIST

Art.-No. / Code	Bild / picture	Beschreibung/description
H125089		Bolzen zum Überrollblech <i>Bolt for bridge plate (rope)</i>
10002682		Profilscharnier mit Feder für Überrollblech an Plattform <i>Hinge with spring for bridge plate mounted at platform</i>
10014357		Schenkelfeder für Scharnier an Plattform <i>Spring for hinge at platform</i>
10002397		Profilscharnier mit Feder für Überrollblech am Bock <i>Hinge with spring for bridge plate mounted to the base plate</i>



AMF-Bruns
Gustav Bruns GmbH & Co. KG | Hauptstraße 101 | 26689 Apen
Telefon +49 (0) 44 89 / 72 72 -22 | Fax +49 (0) 44 89 / 62 45
hubmatik@amf-bruns.de

www.amf-bruns.de



Reg.-Nr.: Q1 0105027



85 ERSATZTEILLISTE / PARTS LIST

Art.-No. / Code	Bild / picture	Beschreibung/description
10010940		<p>Schenkelfeder für Scharnier am Bock</p> <p><i>Spring for hinge at lift side</i></p>
H125030		<p>Abrollsicherung für Linearlift (Abrollblech, 2x Führungsblech, 2x Rolle, Befestigung)</p> <p><i>Roll-off stop for linear lift (incl. guideplates, rolls and bolts)</i></p>
10003077		<p>Führungsblech zur Abrollsicherung</p> <p><i>Guide plate for roll-off stop</i></p>
10013429		<p>Welle zur Abrollsicherung</p> <p><i>Shaft for roll-off stop</i></p>



AMF-Bruns
 Gustav Bruns GmbH & Co. KG | Hauptstraße 101 | 26689 Apen
 Telefon +49 (0) 44 89 / 72 72 -22 | Fax +49 (0) 44 89 / 62 45
 hubmatik@amf-bruns.de





www.amf-bruns.de



Reg.-Nr.: Q1 0105027



86 ERSATZTEILLISTE / PARTS LIST

Art.-No. / Code	Bild / picture	Beschreibung/description
10003441		Rolle zur Abrollsicherung <i>Roll for roll-off stop</i>
10002673		Verdrehfeder 90 Grad, Ausführung rechts, 24 x 195 x 16 mm <i>Torsional spring, 90°, right, 24 x 195 x 16 mm</i>
10002674		Verdrehfeder 90 Grad, Ausführung links, 24 x 195 x 16 mm <i>Torsional spring, 90°, left, 24 x 195 x 16 mm</i>
10002671		Verdrehfeder 90 Grad, Ausführung rechts, 24 x 172 x 16 mm <i>Torsional spring, 90°, right, 24 x 172 x 16 mm</i>



AMF-Brunns
Gustav Bruns GmbH & Co. KG | Hauptstraße 101 | 26689 Apen
Telefon +49 (0) 44 89 / 72 72 -22 | Fax +49 (0) 44 89 / 62 45
hubmatik@amf-bruns.de

www.amf-bruns.de



Reg.-Nr.: Q1 0105027



87 ERSATZTEILLISTE / PARTS LIST

Art.-No. / Code	Bild / picture	Beschreibung/description
10002672		<p>Verdrehfeder 90 Grad, Ausführung links, 24 x 172 x 16 mm</p> <p><i>Torsional spring, 90°, left, 24 x 172 x 16 mm</i></p>
H125137		<p>Drehgelenk für Splittplattform</p> <p><i>Swivel joint for split platform</i></p>
H125135		<p>Scharnier, links unten und rechts oben für EASP-Plattform</p> <p><i>Hinge left bottom and right top for split platform -EASP-</i></p>
H125136		<p>Scharnier, links oben und rechts unten für EASP-Plattform</p> <p><i>Hinge left top and right bottom for split platform -EASP-</i></p>



AMF-Bruns
 Gustav Bruns GmbH & Co. KG | Hauptstraße 101 | 26689 Apen
 Telefon +49 (0) 44 89 / 72 72 -22 | Fax +49 (0) 44 89 / 62 45
 hubmatik@amf-bruns.de

www.amf-bruns.de



Reg.-Nr.: Q1 0105027



88 ERSATZTEILLISTE / PARTS LIST

Art.-No. / Code	Bild / picture	Beschreibung/description
10002630		Gasdruckfeder 250N, Länge 193 mm <i>Gas strut 250N, length: 193 mm</i>
H125199		Kulissenstein EATP <i>Sliding block for telescopic platform</i>
H125200		Seilrolle, groß für Teleskopfunktion <i>Roller, large for telescopic platform</i>
H125202		Seilrolle, klein für Teleskopfunktion <i>Roller, small for telescopic platform</i>



AMF-Brunns
Gustav Bruns GmbH & Co. KG | Hauptstraße 101 | 26689 Apen
Telefon +49 (0) 44 89 / 72 72 -22 | Fax +49 (0) 44 89 / 62 45
hubmatik@amf-bruns.de

www.amf-bruns.de



Reg.-Nr.: Q1 0105027



89 ERSATZTEILLISTE / PARTS LIST

Art.-No. / Code	Bild / picture	Beschreibung/description
H125204		<p>Stahlseil für Teleskopfunktion, Länge 1400 mm</p> <p><i>Steel rope for telescopic platform, 1400 mm</i></p>
10012873		<p>Abdeckung zur Teleskop-Plattform, rechts</p> <p><i>Covering for telescopic platform, right</i></p>
10012874		<p>Abdeckung zur Teleskop-Plattform, links</p> <p><i>Covering for telescopic platform, left</i></p>
H125208		<p>Rotgußscheiben (1 x mit Ansatz, 1 x mit Einlass) inkl. Lager für Teleskop-Grundplattform</p> <p><i>Red brass disc (1 x with lug, 1 x without lug) with bearing for the telescopic operation</i></p>



AMF-Brunns
 Gustav Bruns GmbH & Co. KG | Hauptstraße 101 | 26689 Apen
 Telefon +49 (0) 44 89 / 72 72 -22 | Fax +49 (0) 44 89 / 62 45
 hubmatik@amf-bruns.de

www.amf-bruns.de



Reg.-Nr.: Q1 0105027



90 ERSATZTEILLISTE / PARTS LIST

Art.-No. / Code	Bild / picture	Beschreibung/description
H125209		<p>Rotgußscheibe mit Ansatz inkl. Lager für Teleskop-Plattform (klein)</p> <p><i>Red brass disc with lug and bearing for the telescopic platform (small)</i></p>



AMF-Bruns
Gustav Bruns GmbH & Co. KG | Hauptstraße 101 | 26689 Apen
Telefon +49 (0) 44 89 / 72 72 -22 | Fax +49 (0) 44 89 / 62 45
hubmatik@amf-bruns.de



www.amf-bruns.de



Reg.-Nr.: Q1 0105027



91 ERSATZTEILLISTE / PARTS LIST

Art.-No. / Code	Bild / picture	Beschreibung/description
Ersatzteile für Lift „G“, Bj bis 11/2005 - Special parts for „G“-type only till 11/2005		
H125047		<p>Schenkelfeder zum Tragarm, oben Sonderteil für das „G“-Modell</p> <p><i>Side spring at the top bracket only for „G“-Modell</i></p>
H125048		<p>Schenkelfeder zum Tragarm, unten Sonderteil für das „G“-Modell</p> <p><i>Side spring at the bottom bracket only for „G“-Modell</i></p>
H125049		<p>Schenkelfeder zum Kniegelenk Sonderteil für das „G“-Modell</p> <p><i>Side spring for toggle joint only for „G“-Modell</i></p>
10002705		<p>Paßschraube M16 x 100, Modell „G“ Sonderteil für das „G“-Modell</p> <p><i>Bolt M16, L1=100mm for type „G“ only for „G“-Modell</i></p>



AMF-Bruns
 Gustav Bruns GmbH & Co. KG | Hauptstraße 101 | 26689 Apen
 Telefon +49 (0) 44 89 / 72 72 -22 | Fax +49 (0) 44 89 / 62 45
 hubmatik@amf-bruns.de

www.amf-bruns.de



Reg.-Nr.: Q1 0105027



92 ERSATZTEILLISTE / PARTS LIST

Art.-No. / Code	Bild / picture	Beschreibung/description
Ersatzteile für Lift „G“, Bj bis 11/2005 - Special parts for „G“-type only till 11/2005		
10013323		<p>Buchse zur Paßschraube, außen 30 / 25 mm / innen 16 mm Länge 23 mm (4x) Sonderteil für das „G“-Modell</p> <p><i>Bush for toggle joint, linearlift type „G“ - only for „G“-Modell</i></p>
H125070		<p>Buchse zur Paßschraube, außen 30 / 25 mm / innen 16 mm Länge 15 mm (12x) Sonderteil für das „G“-Modell</p> <p><i>Bush for bolt - only for „G“-Modell</i></p>
10003104		<p>Schenkelfeder, rechts Sonderteil für das „G“-Modell</p> <p><i>Spring for bridge plate, right only for „G“-Modell</i></p>
10003105		<p>Schenkelfeder, links Sonderteil für das „G“-Modell</p> <p><i>Spring for bridge plate, left only for „G“-Modell</i></p>



AMF-Bruns
Gustav Bruns GmbH & Co. KG | Hauptstraße 101 | 26689 Apen
Telefon +49 (0) 44 89 / 72 72 -22 | Fax +49 (0) 44 89 / 62 45
hubmatik@amf-bruns.de





www.amf-bruns.de



Reg.-Nr.: Q1 0105027



93 ERSATZTEILLISTE / PARTS LIST

Art.-No. / Code	Bild / picture	Beschreibung/description
Ersatzteile für Lift „G“, Bj bis 11/2005 - Special parts for „G“-type only till 11/2005		
10003010		<p>Seitenverkleidung, links, schwarz genarbt Sonderteil für das „G“-Modell</p> <p><i>Plastic side cover, left, for type „G“ only for „G“-Modell</i></p>
10003011		<p>Seitenverkleidung, rechts, schwarz genarbt Sonderteil für das „G“-Modell</p> <p><i>Plastic side cover, right, for type „G“ only for „G“-Modell</i></p>
10013130		<p>Seil zum Überrollblech Länge 1925 mm Sonderteil für das „G“-Modell</p> <p><i>Rope from bridge plate length: 1925 mm only for „G“-Modell</i></p>
10013201		<p>Buchse zum Knickgelenk Sonderteil für das „G“-Modell</p> <p><i>Bush for toggle joint only for „G“-Modell</i></p>



AMF-Bruns
Gustav Bruns GmbH & Co. KG | Hauptstraße 101 | 26689 Apen
Telefon +49 (0) 44 89 / 72 72 -22 | Fax +49 (0) 44 89 / 62 45
hubmatik@amf-bruns.de

www.amf-bruns.de



Reg.-Nr.: Q1 0105027



AMF-Bruns
Gustav Bruns GmbH & Co. KG | Hauptstraße 101 | 26689 Apen
Telefon +49 (0) 44 89 / 72 72 -22 | Fax +49 (0) 44 89 / 62 45
hubmatik@amf-bruns.de

www.amf-bruns.de



Reg.-Nr.: Q1 0105027